

SMART 10

W---1S00010

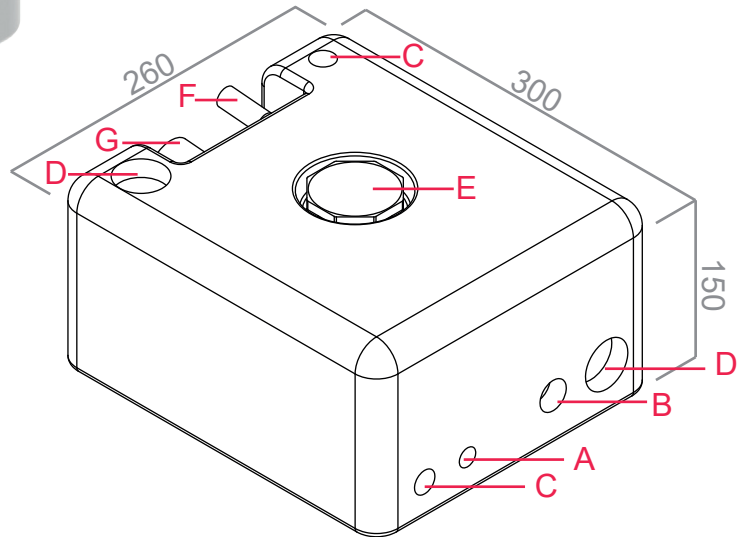
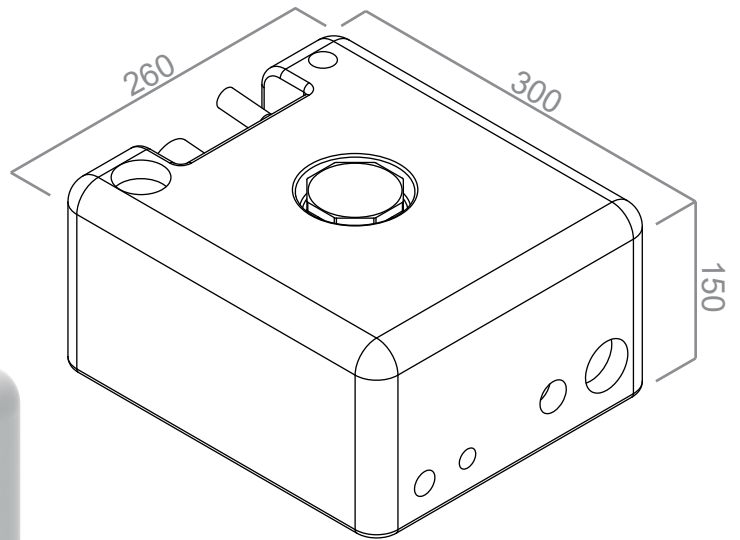

PESO	VOLUME	SPESSORE	A	B	C	D	E	F	G
1,3 kg	8,8 lt	4 mm	N°1 FILETTATURA PE 3/8" GAS	N°1 FILETTATURA PE 3/4" GAS	N°2 FILETTATURA PE 1/2" GAS	N°2 FILETTATURA PE 1" 1/4 GAS	TAPPO MASCHIO 2" GAS	N°1 SFIATO ØE 16 / ØI 11 L 45 MM	N°1 IMBARCO ØE 38 / ØI 30 L 45 MM